

Article number: 20240835530DG

Description: E+G Telescope-Liאר motion bearings GN 2408-35-530-DG

Measures

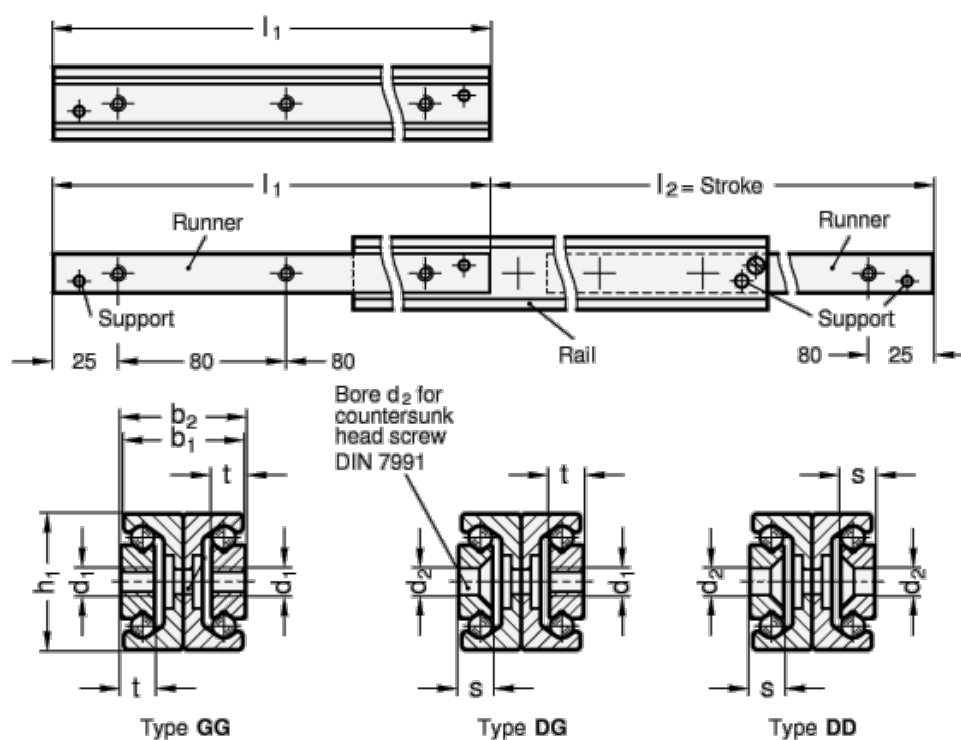

$b_1 = 33$

$b_2 = 34$

$d_1 = M6$

$d_2 = 6.5$

$h_1 = 35$

$L_1 = 530 - 558$

$s = 3.5$

$t =$

Weight in (g) = 3220